

# RAINEY

3316/3346 SQ FT

50  
FT.  
LOT



# RAINEY

50 FT. LOT

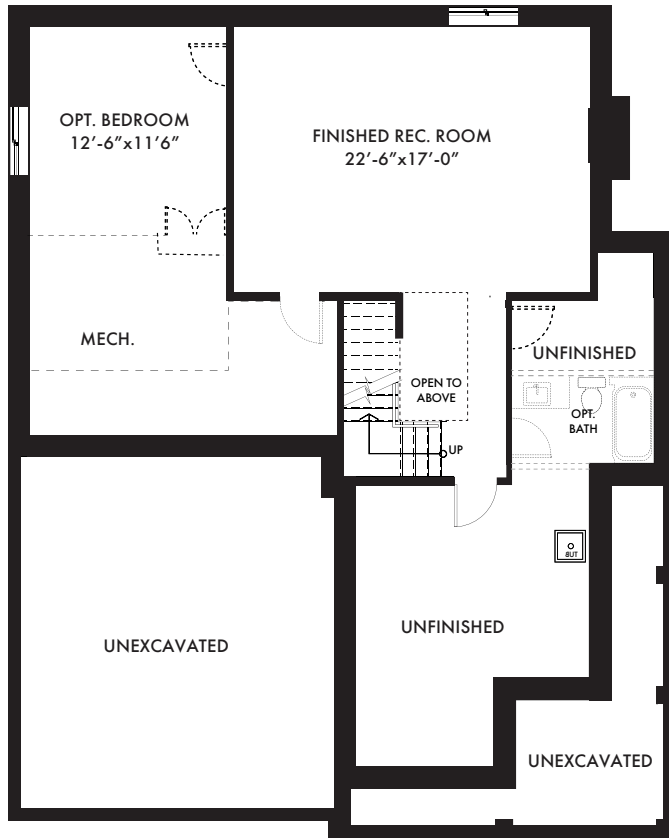

ELEVATION F



ELEVATION C

STANDARD BASEMENT

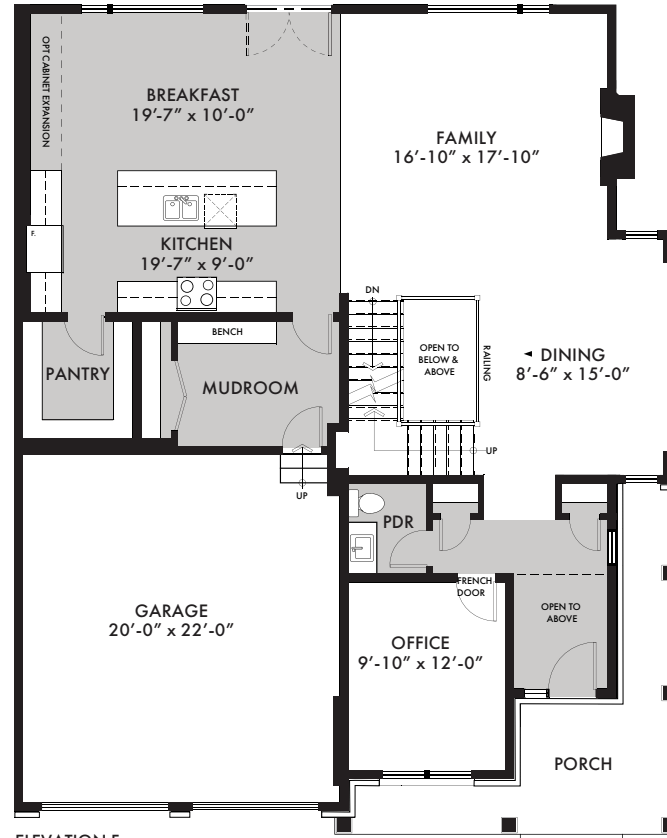

ELEVATION F

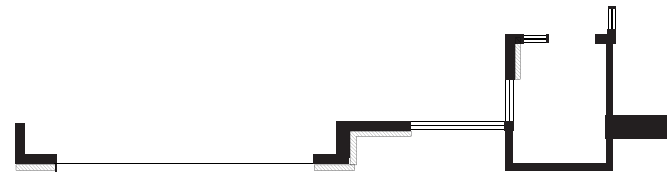

ELEVATION C

STANDARD GROUND FLOOR

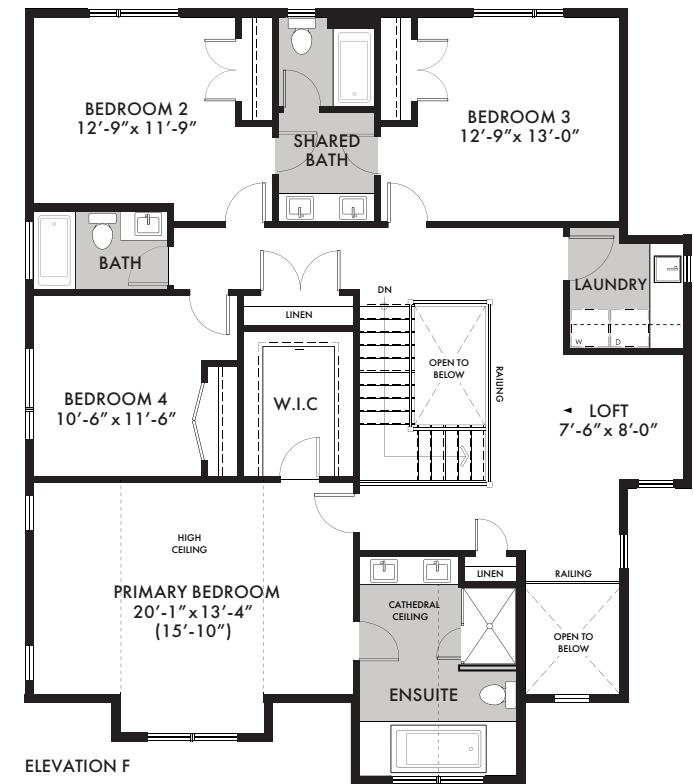

ELEVATION F

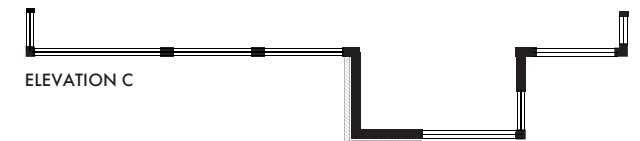

ELEVATION C

STANDARD SECOND FLOOR

# RAINEY

50 FT. LOT

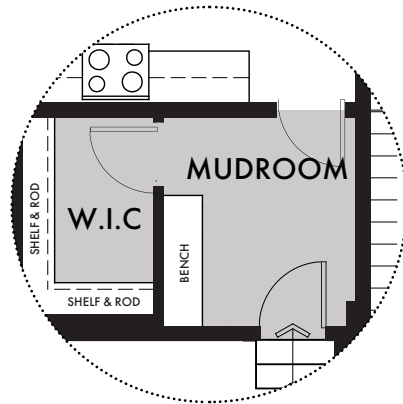
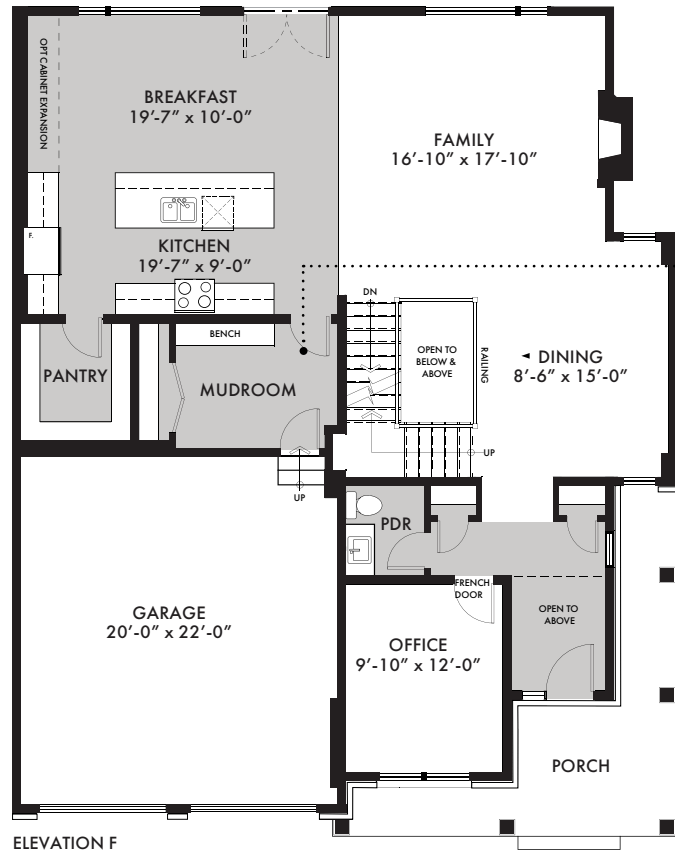

GROUND FLOOR OPT. MUDROOM AND W.I.C.

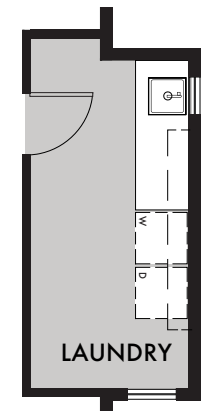
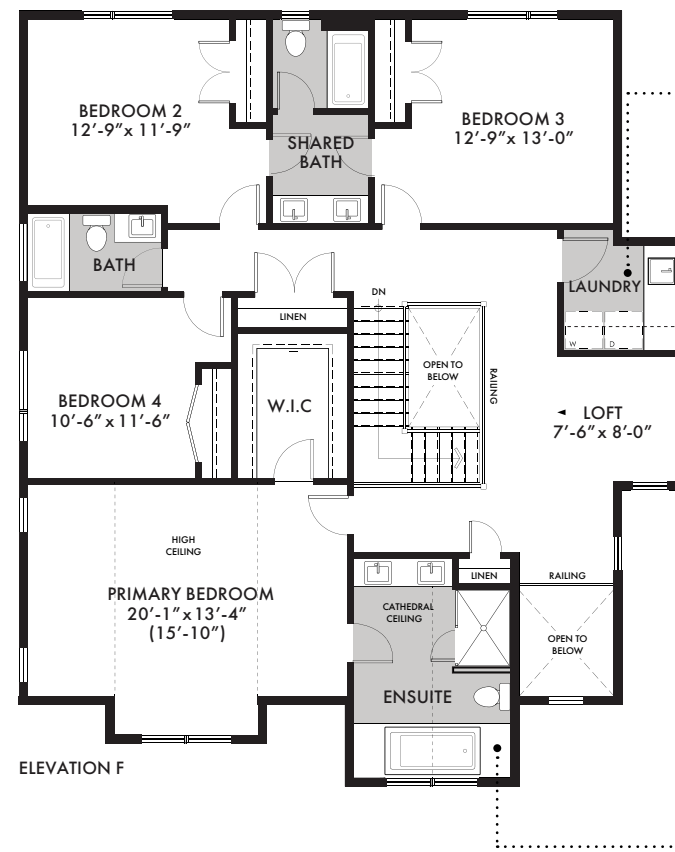

SECOND FLOOR OPT. LAUNDRY

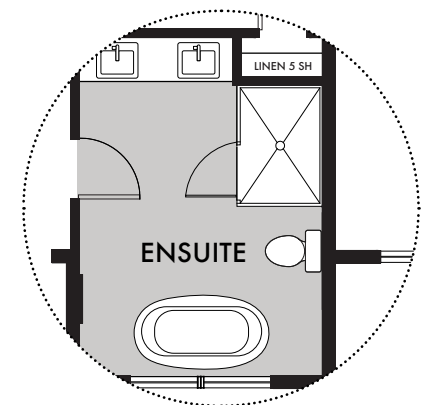

SECOND FLOOR OPT. LUXURY ENSUITE

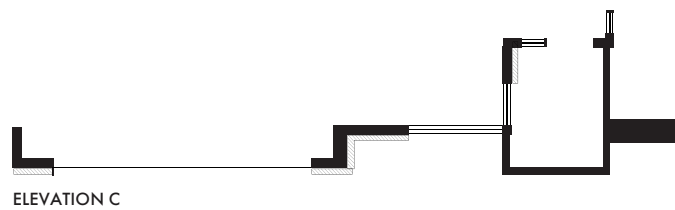

ELEVATION C

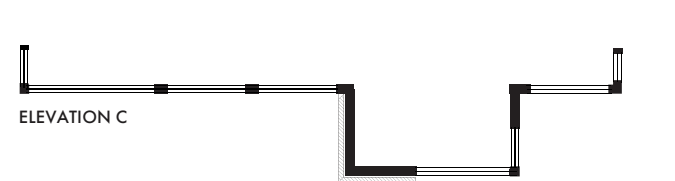

ELEVATION C

STANDARD GROUND FLOOR

STANDARD SECOND FLOOR