

BALDWIN

C/D - 2699 SQ. FT.



BALDWIN

35 FT. LOT

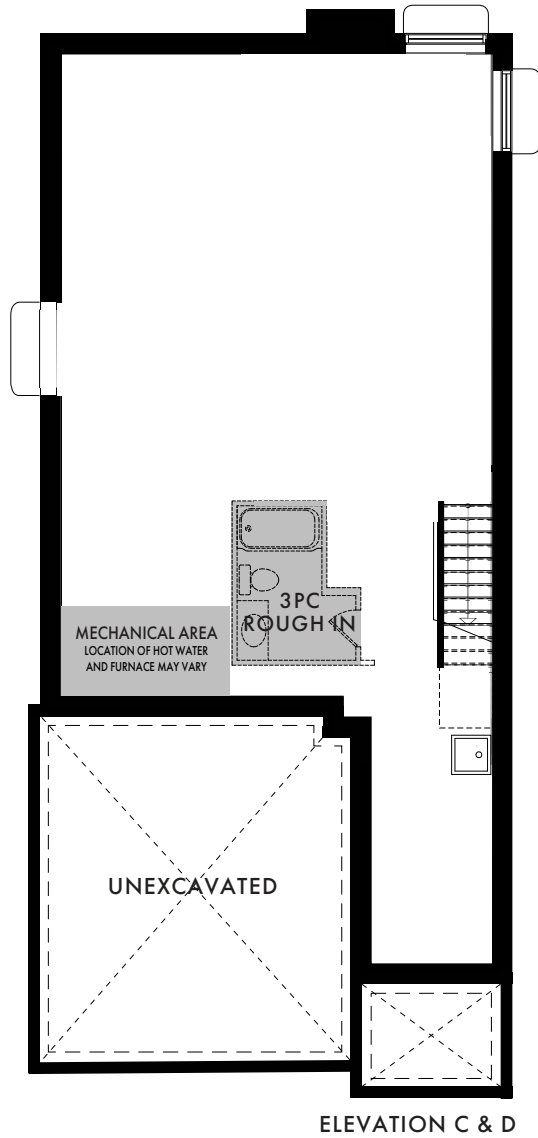

STANDARD BASEMENT

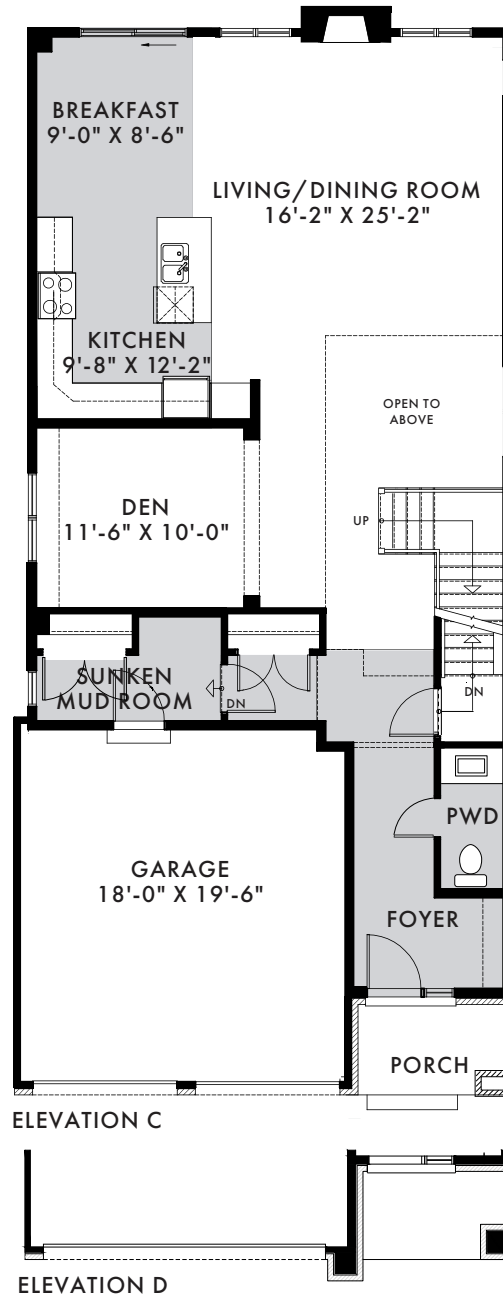

STANDARD GROUND FLOOR



STANDARD SECOND FLOOR
**INCLUDES 75 SQ FT OF OPEN SPACE

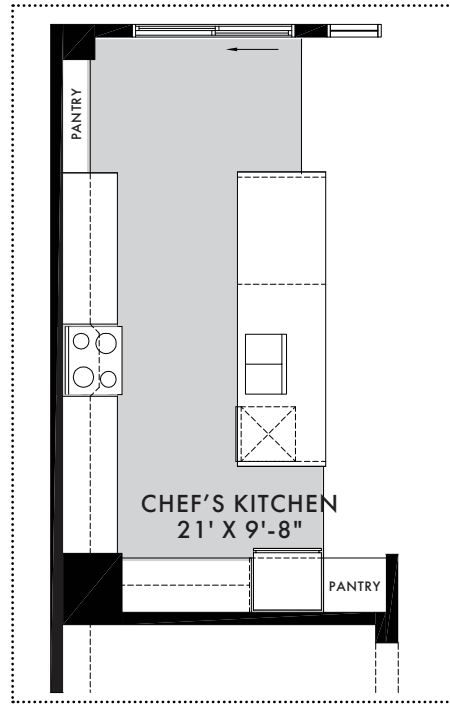

GROUND FLOOR OPTION
CHEFS KITCHEN

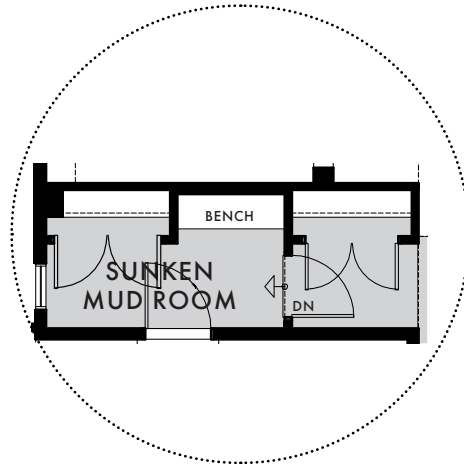

GROUND FLOOR OPTION
MUD ROOM BENCH

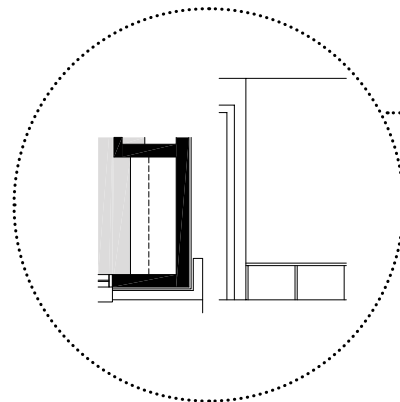

GROUND FLOOR OPTION
FOYER BENCH

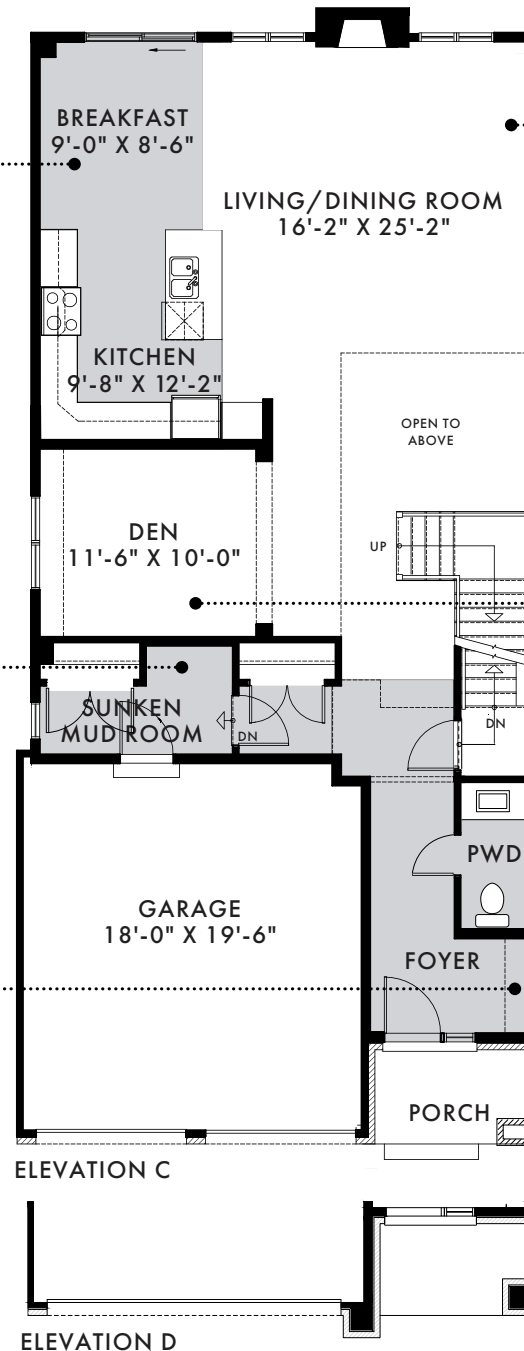

STANDARD GROUND FLOOR

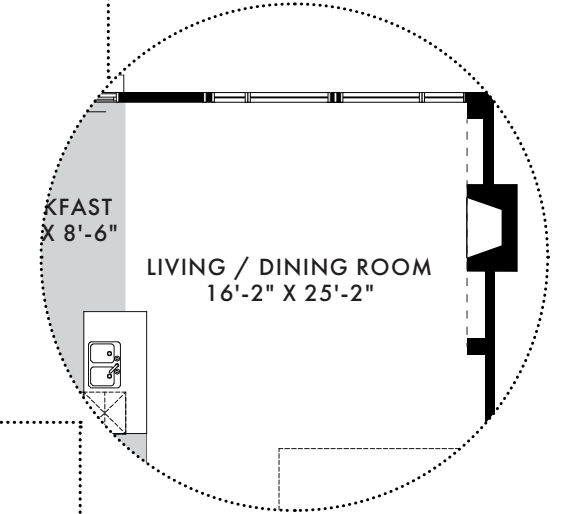

GROUND FLOOR OPTION
FIREPLACE RELOCATION

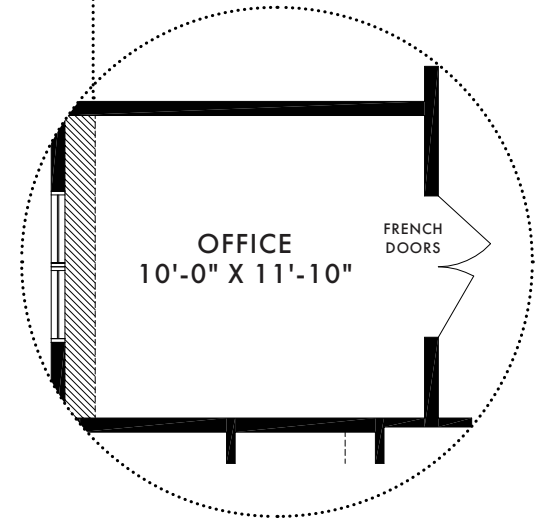

GROUND FLOOR OPTION
OFFICE

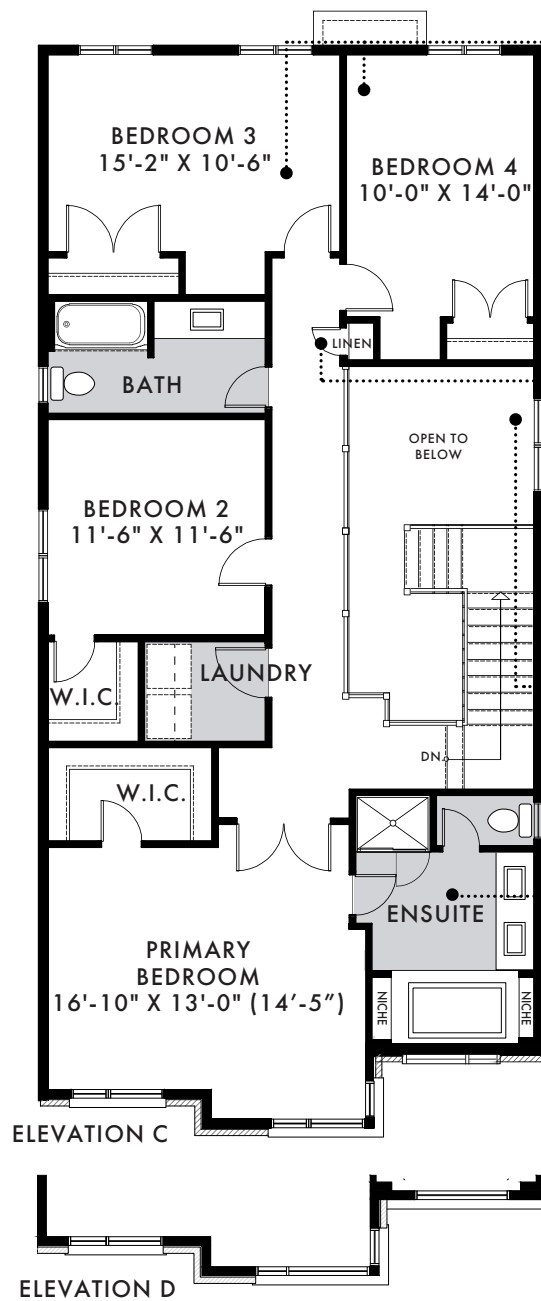

STANDARD SECOND FLOOR
**INCLUDES 75 SQ FT OF OPEN SPACE

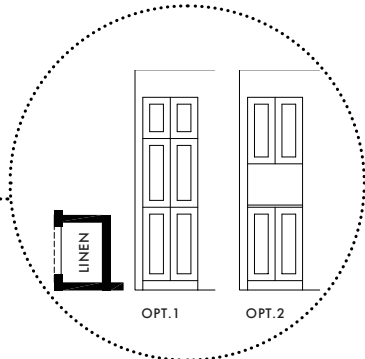

LINEN CENTRE OPT.
24" - 38"

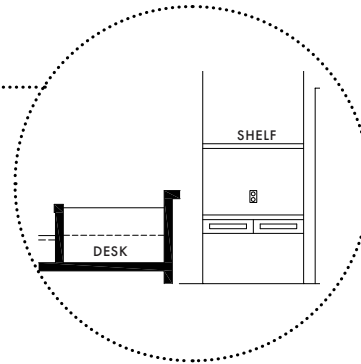

DESK OPTION
BEDROOM 3 & BEDROOM 4

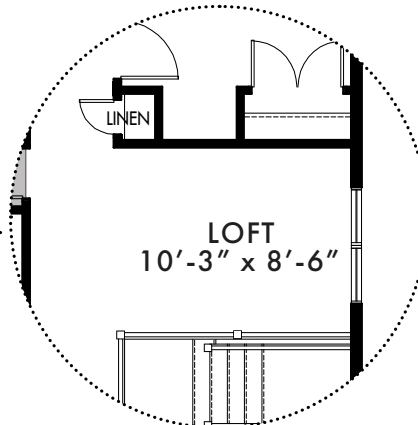

SECOND FLOOR OPT.
LOFT

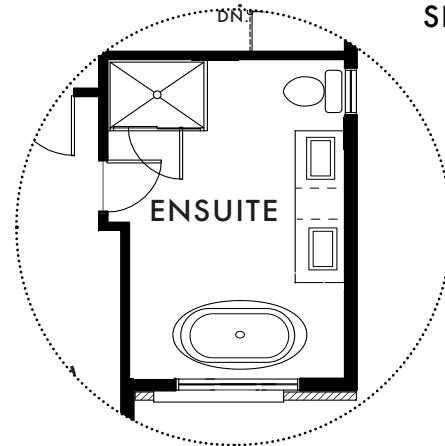

SECOND FLOOR OPT.
ALTERNATE ENSUITE

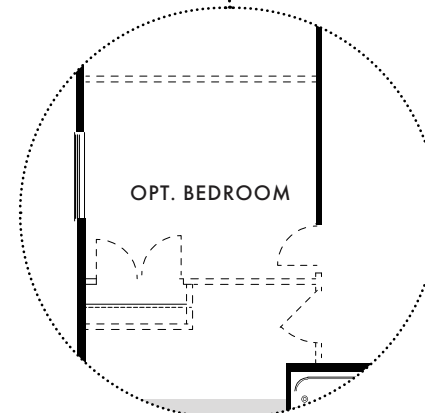

BASEMENT OPTION
BEDROOM

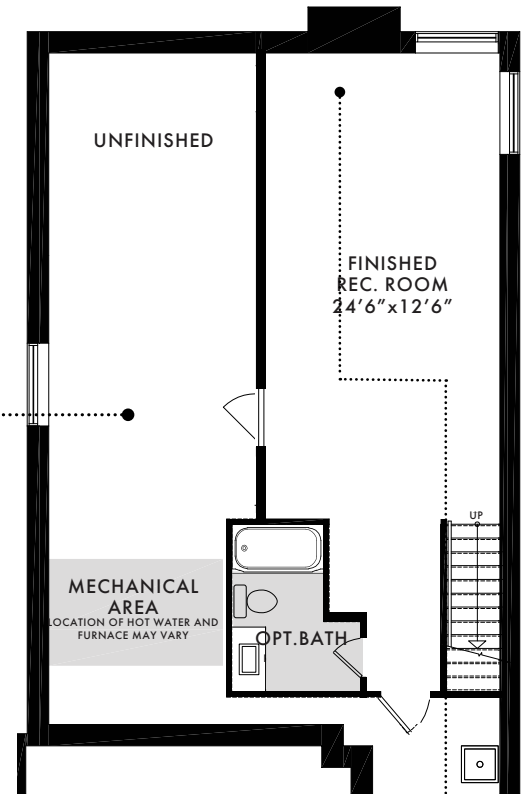

BASEMENT OPTION
REC ROOM AND OPT. BATHROOM

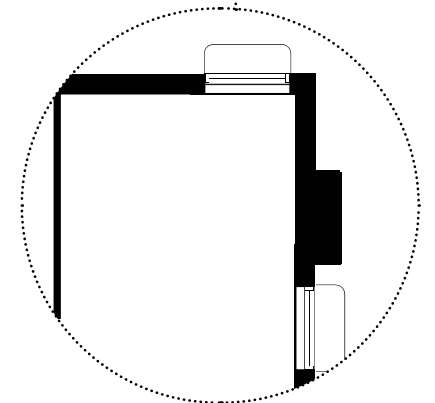

BASEMENT OPTION
FIREPLACE RELOCATION